

Features

- Epitaxial Planar Die Construction
- Complementary PNP Type Available (MMBT2907AT)
- Ultra-Small Surface Mount Package
- Lead Free/RoHS Compliant (Note 2)**

Mechanical Data

- Case: SOT-523
- Case Material: Molded Plastic. UL Flammability Classification Rating 94V-0
- Moisture Sensitivity: Level 1 per J-STD-020C
- Terminals: Solderable per MIL-STD-202, Method 208
- Lead Free Plating (Matte Tin Finish annealed over Alloy 42 leadframe).
- Terminal Connections: See Diagram
- Marking (See Page 4): 1P
- Ordering & Date Code Information, See Page 4
- Weight: 0.002 grams (approximate)

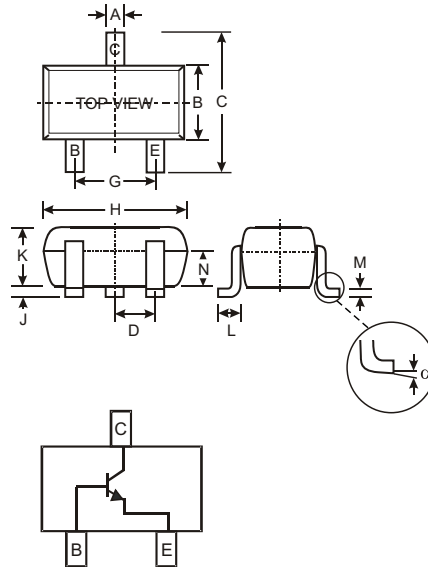

SOT-523			
Dim	Min	Max	Typ
A	0.15	0.30	0.22
B	0.75	0.85	0.80
C	1.45	1.75	1.60
D			0.50
G	0.90	1.10	1.00
H	1.50	1.70	1.60
J	0.00	0.10	0.05
K	0.60	0.80	0.75
L	0.10	0.30	0.22
M	0.10	0.20	0.12
N	0.45	0.65	0.50
	0	8	
All Dimensions in mm			

Maximum Ratings @ T_A = 25 °C unless otherwise specified

Characteristic	Symbol	Value	Unit
Collector-Base Voltage	V _{CBO}	75	V
Collector-Emitter Voltage	V _{CEO}	40	V
Emitter-Base Voltage	V _{EB0}	6.0	V
Collector Current - Continuous	I _C	600	mA
Power Dissipation (Note 1)	P _d	150	mW
Thermal Resistance, Junction to Ambient (Note 1)	R _{JA}	833	°C/W
Operating and Storage Temperature Range	T _J , T _{STG}	-55 to +150	°C

- Notes:
1. Device mounted on FR-4 PCB, 1 inch x 0.85 inch x 0.062 inch; pad layout as shown on Diodes Inc. suggested pad layout document AP02001, which can be found on our website at <http://www.diodes.com/datasheets/ap02001.pdf>.
 2. No purposefully added lead

Electrical Characteristics @ $T_A = 25\text{ C}$ unless otherwise specified

Characteristic	Symbol	Min	Max	Unit	Test Condition
OFF CHARACTERISTICS (Note 3)					
Collector-Base Breakdown Voltage	$V_{(BR)CBO}$	75		V	$I_C = 10\text{ A}, I_E = 0$
Collector-Emitter Breakdown Voltage	$V_{(BR)CEO}$	40		V	$I_C = 10\text{mA}, I_B = 0$
Emitter-Base Breakdown Voltage	$V_{(BR)EBO}$	6.0		V	$I_E = 10\text{ A}, I_C = 0$
Collector Cutoff Current	I_{CEX}		10	nA	$V_{CE} = 60\text{V}, V_{EB(OFF)} = 3.0\text{V}$
Base Cutoff Current	I_{BL}		20	nA	$V_{CE} = 60\text{V}, V_{EB(OFF)} = 3.0\text{V}$
ON CHARACTERISTICS (Note 3)					
DC Current Gain	h_{FE}	35 50 75 100 40			$I_C = 100\text{ A}, V_{CE} = 10\text{V}$ $I_C = 1.0\text{mA}, V_{CE} = 10\text{V}$ $I_C = 10\text{mA}, V_{CE} = 10\text{V}$ $I_C = 150\text{mA}, V_{CE} = 10\text{V}$ $I_C = 500\text{mA}, V_{CE} = 10\text{V}$
Collector-Emitter Saturation Voltage	$V_{CE(SAT)}$		0.3 1.0	V	$I_C = 150\text{mA}, I_B = 15\text{mA}$ $I_C = 500\text{mA}, I_B = 50\text{mA}$
Base-Emitter Saturation Voltage	$V_{BE(SAT)}$	0.6	1.2 2.0	V	$I_C = 150\text{mA}, I_B = 15\text{mA}$ $I_C = 500\text{mA}, I_B = 50\text{mA}$
SMALL SIGNAL CHARACTERISTICS					
Output Capacitance	C_{obo}		8	pF	$V_{CB} = 10\text{V}, f = 1.0\text{MHz}, I_E = 0$
Input Capacitance	C_{ibo}	—	30	pF	$V_{EB} = 0.5\text{V}, f = 1.0\text{MHz}, I_C = 0$
Current Gain-Bandwidth Product	f_T	300		MHz	$V_{CE} = 20\text{V}, I_C = 20\text{mA}, f = 100\text{MHz}$
Input Impedance	h_{ie}	0.25	1.25	k	$V_{CE} = 10\text{ Vdc}, I_C = 10\text{ mAdc}, f = 1.0\text{kHz}$
Voltage Feedback Ratio	h_{re}		4.0	$\times 10^{-4}$	$V_{CE} = 10\text{ Vdc}, I_C = 10\text{ mAdc}, f = 1.0\text{kHz}$
Small-Signal Current Gain	h_{fe}	75	375		$V_{CE} = 10\text{ Vdc}, I_C = 10\text{ mAdc}, f = 1.0\text{kHz}$
Output Admittance	h_{oe}	25	200	S	$V_{CE} = 10\text{ Vdc}, I_C = 10\text{ mAdc}, f = 1.0\text{kHz}$
Noise Figure	NF		4.0	dB	$V_{CE} = 10\text{ Vdc}, I_C = 100\text{ Adc}, R_S = 1.0\text{ k ohms}, f = 1.0\text{kHz}$
SWITCHING CHARACTERISTICS					
Delay Time	t_d		10	ns	$V_{CC} = 30\text{V}, I_C = 150\text{mA}, V_{BE(off)} = -0.5\text{V}, I_{B1} = 15\text{mA}$
Rise Time	t_r		25	ns	
Storage Time	t_s		225	ns	$V_{CC} = 30\text{V}, I_C = 150\text{mA}, I_{B1} = I_{B2} = 15\text{mA}$
Fall Time	t_f		60	ns	

Notes: 3. Short duration pulse test used to minimize self-heating effect.

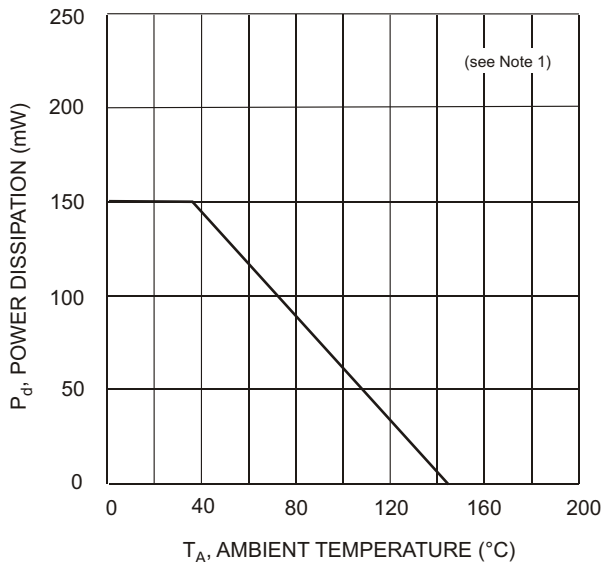

Fig. 1, Power Derating Curve

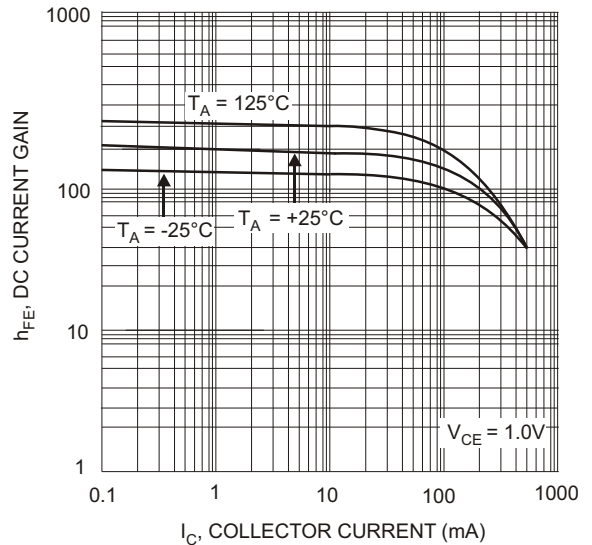

Fig. 2 Typical DC Current Gain vs Collector Current

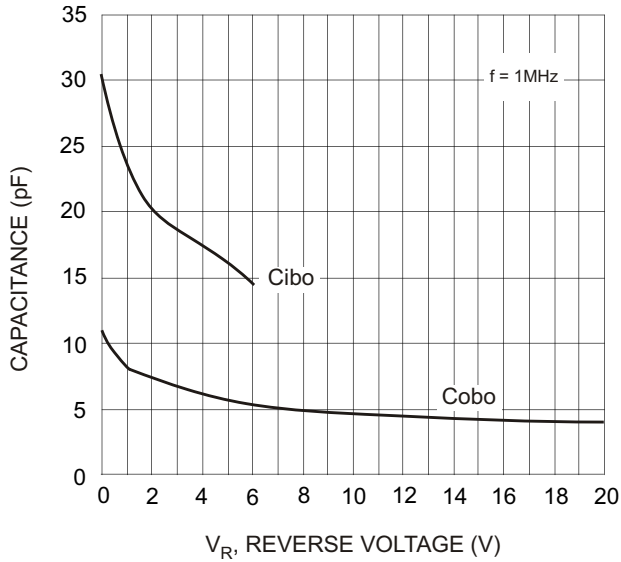

Fig. 3 Typical Capacitance Characteristics

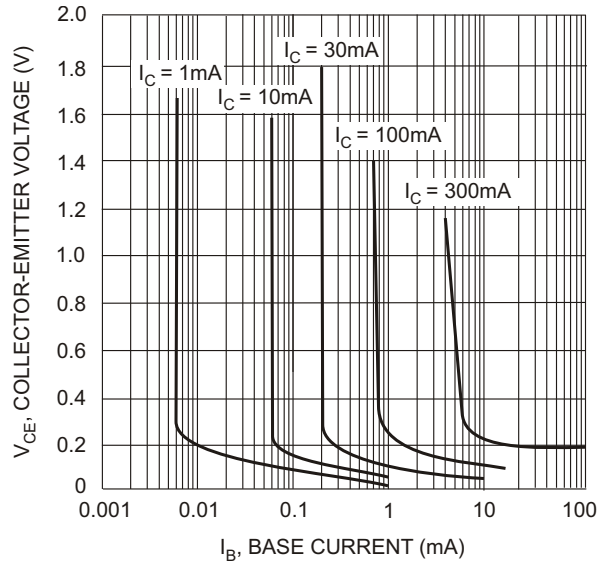

Fig. 4 Typical Collector Saturation Region

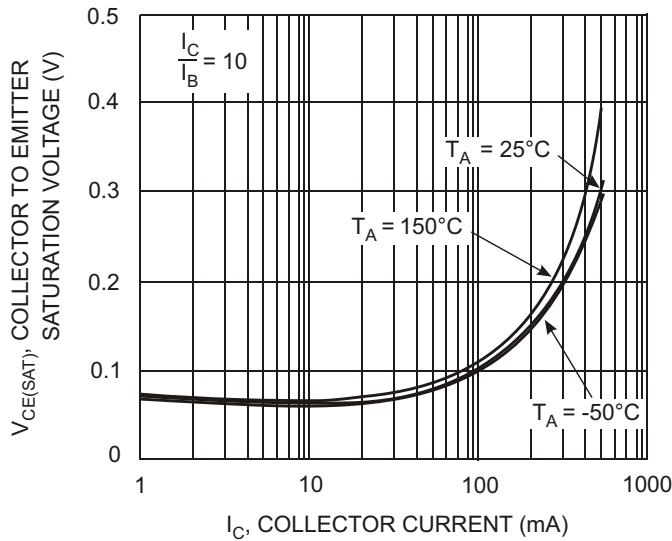

Fig. 5 Collector Emitter Saturation Voltage vs. Collector Current

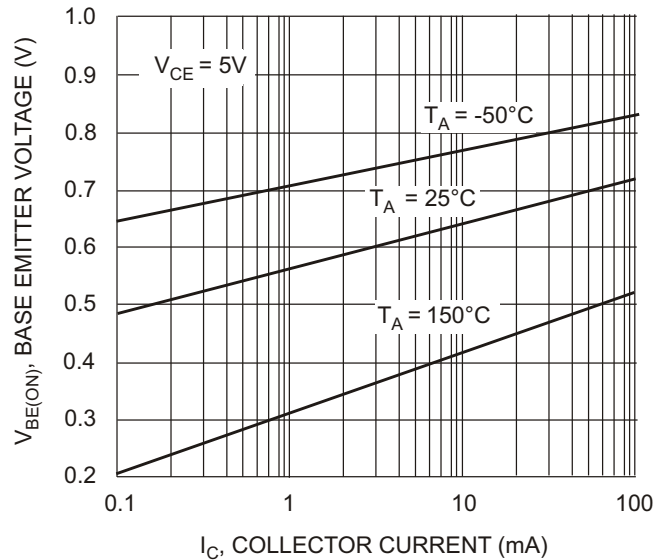

Fig. 6 Base Emitter Voltage vs. Collector Current

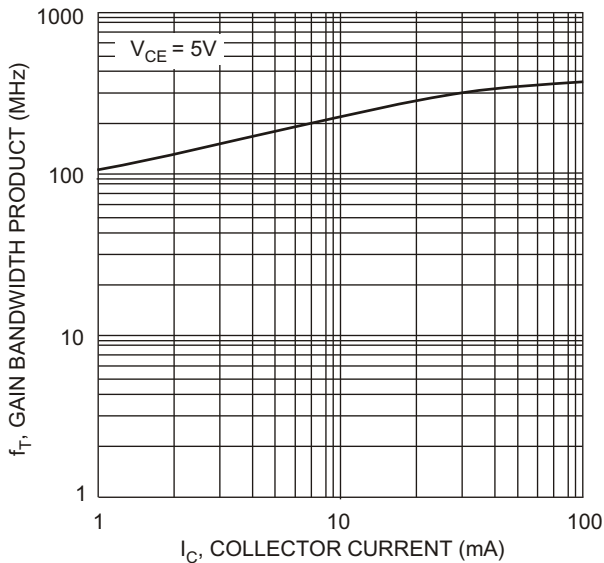

Fig. 7 Gain Bandwidth Product vs. Collector Current

Ordering Information (Note 4)

Device	Packaging	Shipping
MMBT2222AT-7-F	SOT-523	3000/Tape & Reel

Notes: 4. For Packaging Details, go to our website at <http://www.diodes.com/datasheets/ap02007.pdf>.

Marking Information

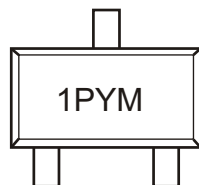

1P = Product Type Marking Code
 YM = Date Code Marking
 Y = Year (ex: N = 2002)
 M = Month (ex: 9 = September)

Date Code Key

Year	1998	1999	2000	2001	2002	2003	2004	2005	2006	2007	2008	2009	2010	2011	2012
Code	J	K	L	M	N	P	R	S	T	U	V	W	X	Y	Z

Month	Jan	Feb	March	Apr	May	Jun	Jul	Aug	Sep	Oct	Nov	Dec
Code	1	2	3	4	5	6	7	8	9	O	N	D

IMPORTANT NOTICE

Diodes Incorporated and its subsidiaries reserve the right to make modifications, enhancements, improvements, corrections or other changes without further notice to any product herein. Diodes Incorporated does not assume any liability arising out of the application or use of any product described herein; neither does it convey any license under its patent rights, nor the rights of others. The user of products in such applications shall assume all risks of such use and will agree to hold Diodes Incorporated and all the companies whose products are represented on our website, harmless against all damages.

LIFE SUPPORT

Diodes Incorporated products are not authorized for use as critical components in life support devices or systems without the expressed written approval of the President of Diodes Incorporated.